

16023000006001
WIRING DIAGRAM
(INDOOR UNIT)

INDOOR UNIT MAINBOARD

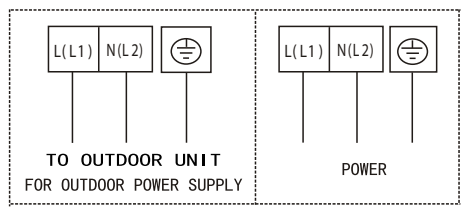

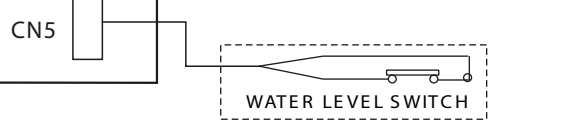
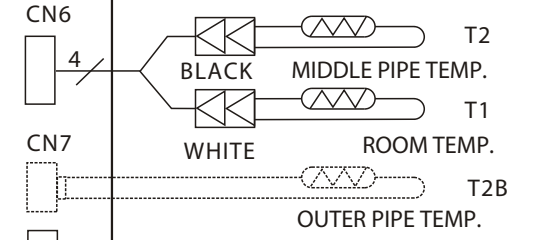
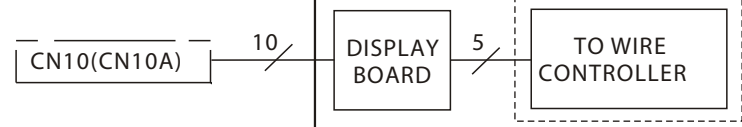
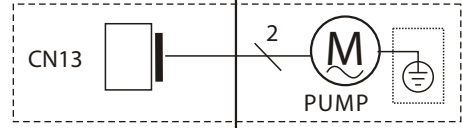
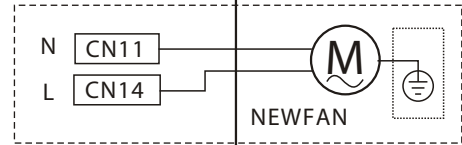
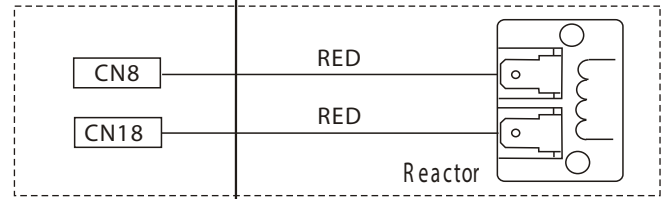
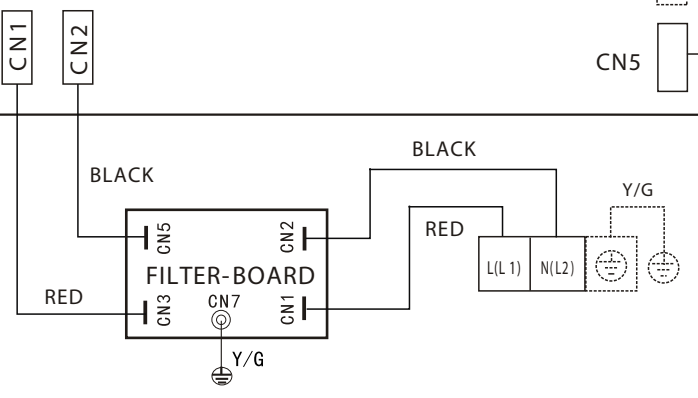
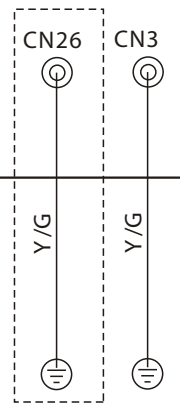
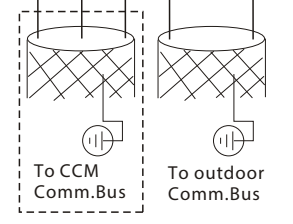
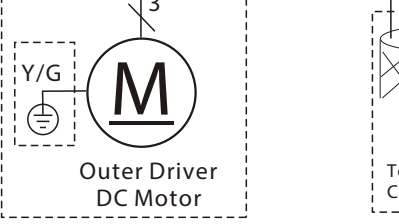
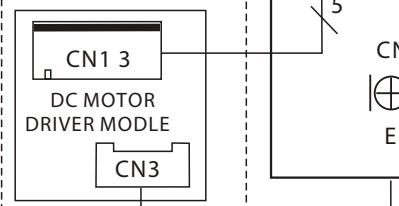
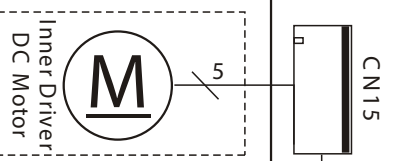
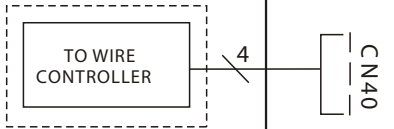
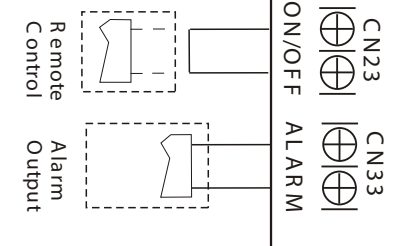
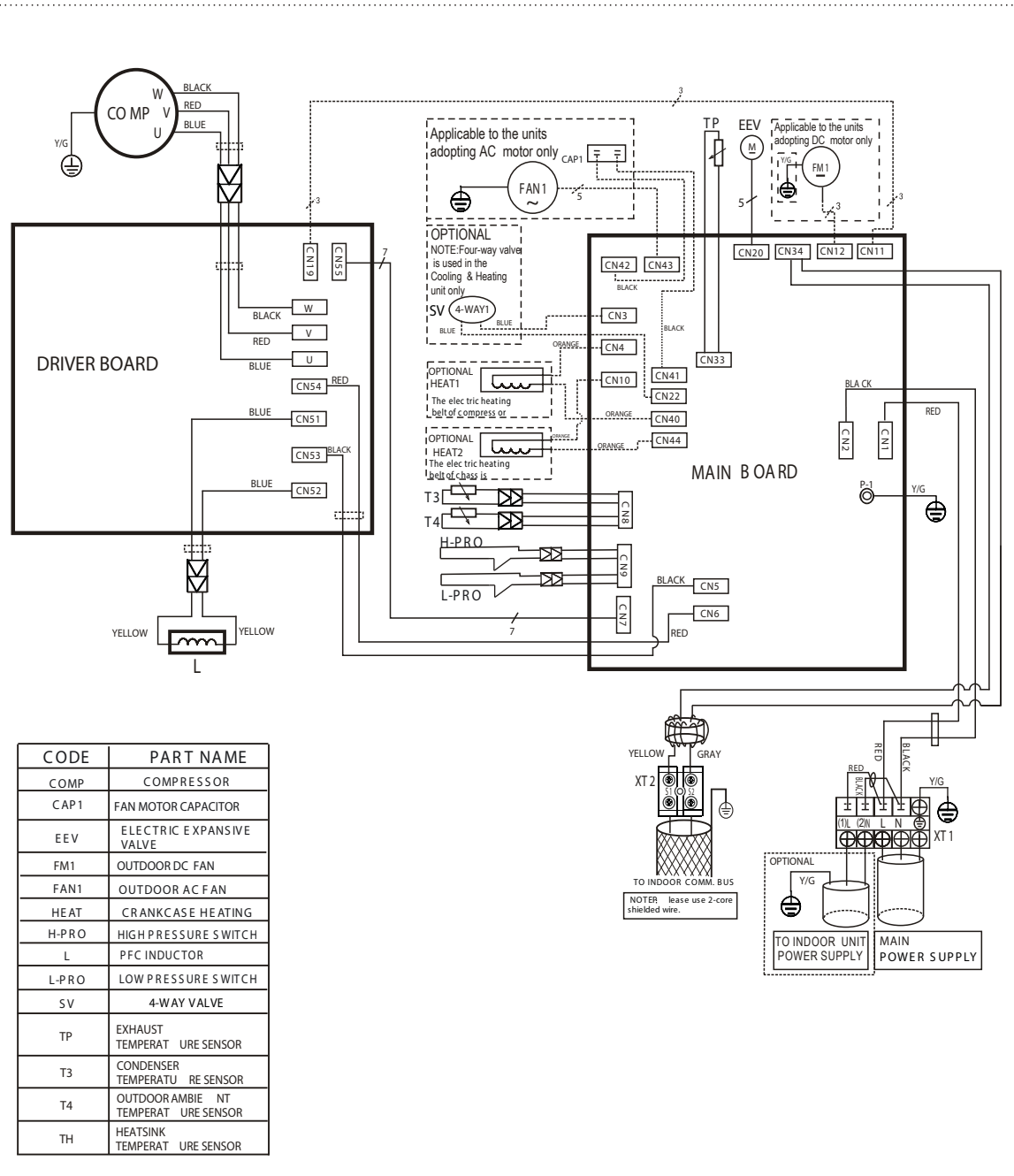

CODE	PART NAME
COMP	COMPRESSOR
CAP1	FAN MOTOR CAPACITOR
EEV	ELECTRIC EXPANSIVE VALVE
FM1	OUTDOOR DC FAN
FAN1	OUTDOOR AC FAN
HEAT	CRANKCASE HEATING
H-PRO	HIGH PRESSURE SWITCH
L	PFC INDUCTOR
L-PRO	LOW PRESSURE SWITCH
SV	4-WAY VALVE
TP	EXHAUST TEMPERATURE SENSOR
T3	CONDENSER TEMPERATURE SENSOR
T4	OUTDOOR AMBIENT TEMPERATURE SENSOR
TH	HEATSINK TEMPERATURE SENSOR